

 **cybex**
GOLD

GAZELLE S





EN WARNING
DE WARNUNG
ES ADVERTENCIA
FR AVERTISSEMENT
PT AVISOS
IT ATTENZIONE
NL WAARSCHUWING
PL OSTRZEŻENIE
CS UPOZORNĚNÍ
SK UPOZORNENIE
SL OPOZORILO
HR UPOZORENJE
HU FIGYELMEZTETÉS
SE VARNING
NO ADVARSEL
FI VAROITUS
DA ADVARSEL
ET HOIATUS
LV BRĪDINĀJUMS
LT PERSPĖJIMAS
RU ВНИМАНИЕ
UK УВАГА
TR UYARI
EL ΠΡΟΕΙΔΟΠΟΙΗΣΗ
RO AVERTISMENTE
IS VIÐVÖRUN
MT TWISSIJA

AR
FA
YUE 警告
CMN 警告
JA 警告
KO 경고
BG ПРЕДУПРЕЖДЕНИЕ
SR UPOZORENJE
MS AMARAN
HI चेतावनी
TH คำเตือน
SQ PARALAJMËRIM
BS UPOZORENJE
ME UPOZORENJE
MK ПРЕДУПРЕДУВАЊЕ
HY ՉԳՈՒՇԱՑՈՒՄ
VI CẢNH BÁO

تحذير
اخطار



EN Tutorial video
DE Videoanleitung
ES Tutorial en vídeo
FR Vidéo de démonstration
PT Video tutorial
IT Video tutorial
NL Instructievideo
PL Film instruktażowy
CS Výukové video
SK Výukové video
SL Video z navodili
HR Video s uputama
HU Bemutatóvideó
SE Videosjälvstudiekurs
NO Opplæringsvideo
FI Opetusvideo
DA Vejledende video
ET Õppevideo
LV Ar mācību video
LT Mokomasis vaizdo įrašas
RU Обучающее видео
UK Навчальне відео
TR Öğretici video
EL Εκπαιδευτικό βίντεο
RO Video tutorial
IS Kennslumyndband
MT Tutorial fuq vidjow

AR
FA
YUE 教程視頻
CMN 教程视频
JA チュートリアルビデオ
KO 튜토리얼 동영상
BG Учебно видео
SR Video sa uputstvima
MS Video tutorial
HI ट्यूटोरियल वीडियो
TH ฝึกอบรม
SQ Video udhëzuese
BS Video sa uputstvima
ME Video sa uputstvima
MK Видеоупатство
HY Παιδαγωγικό βίντεο
VI Video hướng dẫn

فیدویو تعلیمی
ویدئوی آموزشی



EN	Configurations	TR	Kurulum Şekilleri
DE	Konfigurationen	EL	Ρυθμίσεις
ES	Configuraciones	RO	Configurații
FR	Configurations	IS	Stillingar
PT	Configurações	MT	Konfigurazzjonijiet
IT	Configurazione	AR	الإعدادات
NL	Configuraties	FA	پیکربندی‌ها
PL	Konfiguracje	YUE	配置
CS	Konfigurace	CMN	配置
SK	Konfigurácie	JA	構成
SL	Konfiguracije	KO	구성
HR	Konfiguracije	BG	Конфигурации
HU	Konfigurációk	SR	Konfiguracije
SE	Konfigurationer	MS	Konfigurasi
NO	Konfigurasjoner	HI	कॉन्फिगरेशन
FI	Määrittelykset	TH	การกำหนดค่า
DA	Konfigurationer	SQ	Konfigurimet
ET	Konfiguratsioonid	BS	Konfiguracije
LV	Konfigurācija	ME	Konfiguracije
LT	Konfigūracijos	MK	Конфигурации
RU	Конфигурации	HY	Վաղմիակներ
UK	Конфігурації	VI	Thông số cấu hình



EN	Maximum weights	TR	Maksimum ağırlıklar
DE	Maximalgewichte	EL	Μέγιστο βάρος
ES	Pesos máximos	RO	Greutăți maxime
FR	Poids maximum	IS	Hámarksþyngd
PT	Pesos máximos	MT	Piżżijiet massimi
IT	Peso massimo	AR	الأوزان القصوى
NL	Maximumgewicht	FA	حداکثر وزن
PL	Dopuszczalna waga	YUE	最大重量
CS	Maximální hmotnosti	CMN	最大重量
SK	Maximálne hmotnosti	JA	最大重量
SL	Največje teže	KO	최대 하중
HR	Maksimalne težine	BG	Максимални тегла
HU	Maximális súlyok	SR	Maksimalne težine
SE	Max.vikter	MS	Berat maksimum
NO	Maksimumsvektar	HI	अधिकतम वजन
FI	Enimmäispainot	TH	น้ำหนักสูงสุด
DA	Maksimumvægt	SQ	Peshat maksimale
ET	Maksimaalne kaal	BS	Maksimalne težine
LV	Maksimālais svars	ME	Maksimalne težine
LT	Didžiausi svoriai	MK	Максимални тежини
RU	Максимальная масса	HY	Առավելագույն քաշեր
UK	Максимальна вага	VI	Các mức cân nặng tối đa



= 18

EN	Product registration	TR	Ürün kaydı
DE	Produktregistrierung	EL	Καταχώριση προϊόντος
ES	Registro del producto	RO	Înregistrarea produsului
FR	Enregistrement du produit	IS	Skráning tækis
PT	Registo do produto	MT	Reġistrazzjoni tal-prodott
IT	Registrazione del prodotto	AR	تسجيل المنتج
NL	Productregistratie	FA	ثبت محصول
PL	Rejestracja produktu	YUE	產品註冊
CS	Registrace výrobku	CMN	产品注册
SK	Registrácia výrobku	JA	製品の登録
SL	Registracija izdelka	KO	제품 등록
HR	Registracija proizvoda	BG	Регистрация на продукта
HU	Termékregisztráció	SR	Registracija proizvoda
SE	Produktregistrering	MS	Pendaftaran produk
NO	Produktregistrering	HI	उत्पाद पंजीकरण
FI	Tuotteen rekisteröinti	TH	การลงทะเบียนผลิตภัณฑ์
DA	Produktregistrering	SQ	Regjistrimi i produktit
ET	Toote registreerimine	BS	Registracija proizvoda
LV	Produkta registrācija	ME	Registracija proizvoda
LT	Gaminio registracija	MK	Регистрација на производ
RU	Регистрация продукта	HY	Ապրանքի գրանցում
UK	Реєстрація продукту	VI	Đăng ký sản phẩm



= 20

EN	Set up	TR	Kurulum
DE	Aufbau	EL	Στήσιμο
ES	Instalación	RO	Setare
FR	Montage	IS	Uppsetning
PT	Preparação	MT	Konfigurazzjoni
IT	Configurazione	AR	تنصيب
NL	Opbouw	FA	برپا کردن
PL	Montaż	YUE	設置
CS	Nastavení	CMN	设置
SK	Nastavenie	JA	セットアップ
SL	Nastavitev	KO	설정
HR	Postavljanje	BG	Настройка
HU	Felszerelés	SR	Postavljanje
SE	Inställning	MS	Persediaan
NO	Oppsett	HI	सेट अप
FI	Asennus	TH	การติดตั้ง
DA	Opsætning	SQ	Konfigurimi
ET	Seadistamine	BS	Postavljanje
LV	Uzstādīšana	ME	Postavljanje
LT	Nuostatos	MK	Поставување
RU	Установка	HY	Շարժավորում
UK	Встановлення	VI	Cài đặt

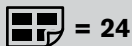

EN	Adjusting seat adapter	ET	Istme adapteri reguleerimine	SR	Podešavanje adaptera sedišta	BS	Podešavanje adaptera sjedišta
DE	Einstellung des Sitzadapters	LV	Sēdekļa adaptera regulēšana	MS	Melaraskan penyesuai tempat duduk	ME	Podešavanje adaptera sjedišta
ES	Ajuste del adaptador del asiento	LT	Kėdutės adapterio reguliavimas	HI	सीट एडॉप्टर समायोजित करना	MK	Приспособување на адаптерот за седиште
FR	Régler l'adaptateur de siège	RU	Регулировка адаптера кресла	TH	การปรับอะแดปเตอร์ที่นั่ง	HY	Լստառտեղի ադապտերի հարմարեցում
PT	Ajuste do adaptador de assento	UK	Регулювання адаптера крісла	SQ	Përdorimi i adaptorit të sexholinos	VI	Điều chỉnh bộ phận điều hợp ghế ngồi
IT	Regolazione dell'adattatore del seggiolino	TR	Koltuk adaptörünün ayarlanması				
NL	De adapter van het autostoeltje aanpassen	EL	Προσαρμογή του αντάπτορα καθίσματος				
PL	Dostosowywanie adaptera fotelika	RO	Reglarea adaptorului scaunului				
CS	Nastavení adaptéru sedadla	IS	Stilla sætismillistykki				
SK	Nastavenie adaptéra sedadla	MT	Kif taġġuġta l-adapter tas-sedil				
SL	Prilaganje adapterja za sedež	AR	تعديل محول المقعد				
HR	Podešavanje adaptera sjedala	FA	تنظیم آداپتور صندلی				
HU	Az ülésadapter beállítás	YUE	調節座椅適配器				
SE	Justera sitsadaptern	CMN	调节座椅适配器				
NO	Justering av seteadapter	JA	シート調節アダプター				
FI	Istuimen säätöadapteri	KO	시트 어댑터 조정하기				
DA	Indstilling af sædeadapteren	BG	Регулиране на адап				



 = 27

EN	Shopping basket	TR	Alışveriş sepeti
DE	Einkaufskorb	EL	Καλάθι αγορών
ES	Cesta de la compra	RO	Coș de cumpărături
FR	Panier	IS	Innkaupakarfa
PT	Cesta porta-objetos	MT	Basket tax-shopping
IT	Carrello per la spesa	AR	سلة التسوق
NL	Winkelwagentje	FA	سبد خرید
PL	Koszyk na zakupy	YUE	購物籃
CS	Nákupní košík	CMN	购物篮
SK	Nákupný košík	JA	買い物かご
SL	Nakupovalna košara	KO	장바구니
HR	Košara za kupovinu	BG	Корба за пазар
HU	Nakupovalna košara	SR	Korpa za kupovinu
SE	Shoppingväska	MS	Bakul membeli-belah
NO	Handlekurv	HI	शॉपिंग बास्केट
FI	Ostoskori	TH	ตะกร้าสินค้า
DA	Indkøbskurv	SQ	Koshi i pazarit
ET	Pakikorv	BS	Korpa za kupovinu
LV	Iepirkumu grozs	ME	Korpa za kupovinu
LT	Pirkinių krepšelis	MK	Корпа за покупки
RU	Корзина покупателя	HY	Առևտրի զամբյուղ
UK	Корзина для покупок	VI	Giỏ mua sắm



 = 32

EN	Brake	TR	Fren	
DE	Bremse	EL	Φρένα	
ES	Freno	RO	Frână	
FR	Frein	IS	Bremsa	
PT	Bloqueio	MT	Brejik	
IT	Freno	AR		المكابح
NL	Rem	FA		ترمز
PL	Hamulec	YUE	剎車	
CS	Brzda	CMN	刹车	
SK	Brzda	JA	ブレーキ	
SL	Zavora	KO	브레이크	
HR	Kočnica	BG	Спирачка	
HU	Fék	SR	Kočnica	
SE	Broms	MS	Brek	
NO	Brems	HI	ब्रेक	
FI	Jarru	TH	เบรค	
DA	Bremse	SQ	Frenat	
ET	Pidur	BS	Kočnica	
LV	Bremze	ME	Kočnica	
LT	Stabdys	MK	Сопирачка	
RU	Тормоза	HY	Արգելակ	
UK	Гальма	VI	Phanh thắng	



 = 33

EN	Folding	TR	Katlama
DE	Faltung	EL	Αναδίπλωση
ES	Plegado	RO	Pliere
FR	Pliant	IS	Brjóta saman
PT	Fecho	MT	Tiwi
IT	Ripiegamento	AR	
NL	Vouwen	FA	
PL	Składanie	YUE	折疊
CS	Skládání	CMN	折疊
SK	Zloženie	JA	折りたたみ
SL	Zlaganje	KO	접기
HR	Preklapanje	BG	Сгъване
HU	Összecsukás	SR	Preklapanje
SE	Ihopfällning	MS	Lipat
NO	Sammenlegging	HI	फोल्डिंग
FI	Kokoon taittaminen	TH	การพับ
DA	Sammenklapning	SQ	Palosja
ET	Kokkuvoltimine	BS	Preklapanje
LV	Salocīšana	ME	Preklapanje
LT	Lankstymas	MK	Склопување
RU	Складывание	HY	Ծախելը
UK	Складання	VI	Gập lại

قابلية للطي
تا کردن



 = 36

EN	Harness	TR	Emniyet kemeri
DE	Gurtsystem	EL	Συγκράτηση
ES	Arnés	RO	Centură
FR	Harnais	IS	Beisli
PT	Arnês	MT	Ċinga tas-sigurtà
IT	Imbracatura	AR	طقم الشد
NL	Harnas	FA	سیدستم مهار
PL	Szelki	YUE	安全帶
CS	Popruh	CMN	安全帶
SK	Popruh	JA	安全ベルト
SL	Varnostni pas	KO	하네스
HR	Sustav vezivanja	BG	Сбруя
HU	Biztonsági öv	SR	Sistem vezivanja
SE	Sele	MS	Abah-abah
NO	Beltesystem	HI	कबच
FI	Vyöjärjestelmä	TH	ระบบสายรัด
DA	Selesystem	SQ	Pajimet
ET	Turvarihmad	BS	Sistem vezivanja
LV	Drošības josta	ME	Sistem vezivanja
LT	Diržai	MK	Сигурносен каиш
RU	Ремни безопасности	HY	Ամրագրուի
UK	Ремінь	VI	Dây an toàn

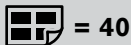

EN	Bumper bar	TR	Tampon çubuğu
DE	Schutzbügel	EL	Μπάρα διάταξης προστασίας
ES	Barra de seguridad	RO	Bară de protecție
FR	Barre de protection	IS	Pverbiti
PT	Barra de segurança	MT	Strixxa tal-bumper
IT	Barra paraurti	AR	عارضة ممتص الصدمات
NL	Veiligheidsbeugel	FA	میله ضربگیر
PL	Pałak zabezpieczający	YUE	保險杠
CS	Dětské madlo	CMN	保險杠
SK	Detská rúčka	JA	バンパーバー
SL	Varnostni lok	KO	범퍼 바
HR	Štitnik	BG	Броня
HU	Karfa	SR	Štitnik
SE	Stötfångare	MS	Bar bumper
NO	Fender	HI	बम्पर बार
FI	Suojakaari	TH	แถบกันชน
DA	Sikkerhedsbøjle	SQ	Shufra e parakolpit
ET	Turvakaar	BS	Štitnik
LV	Aizsargloks	ME	Štitnik
LT	Amortizatoriaus strypas	MK	Одбојник
RU	Поручень	HY	Թափարգել
UK	Обмежувальний поручень	VI	Thanh chống va đập

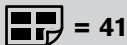

EN	Seat direction	TR	Koltuk yönü
DE	Sitzrichtung	EL	Κατεύθυνση καθίσματος
ES	Dirección de la silla	RO	Direcție scaun
FR	Sens du siège	IS	Sættisstefna
PT	Orientação do assento	MT	Direzżjoni tas-sit
IT	Direzione di seduta	AR	اتجاه المقعد
NL	Zitrichting	FA	جهت صندلی
PL	Kierunek siedzenia	YUE	座椅方向
CS	Směr sedadla	CMN	座椅方向
SK	Smer sedadla	JA	シートの方向
SL	Smer sedeža	KO	좌석 방향
HR	Smjer sjedala	BG	Посока на седалката
HU	Ülésirány	SR	Smer sedišta
SE	Sitsriktning	MS	Arah kerusi
NO	Seteretning	HI	सीट दिशा
FI	Istumasuunta	TH	ทิศทางการที่นั่ง
DA	Sæderetning	SQ	Drejtimi i ndenjësës
ET	Istme suund	BS	Smjer sjedišta
LV	Sēdekļa virziens	ME	Smjer sjedišta
LT	Kėdutės kryptis	MK	Правец на седиште
RU	Направление сиденья	HY	Նստատեղի ուղղություն
UK	Напрямок сидіння	VI	Hướng ghế ngồi



= 42

EN	Backrest	TR	Arkalık
DE	Rückenlehne	EL	Πλάτη
ES	Respaldo	RO	Spătar
FR	Dossier	IS	Bak
PT	Encosto de costas	MT	Serħ id-dahar
IT	Schienale	AR	ميمسد الظهر
NL	Rugleuning	FA	پشتی
PL	Oparcie	YUE	靠背
CS	Opěradlo	CMN	靠背
SK	Operadlo	JA	背もたれ
SL	Naslonjalo	KO	등받이
HR	Naslon	BG	Облегалка
HU	Háttámla	SR	Naslon
SE	Ryggstöd	MS	Penyandar belakang
NO	Rygglene	HI	वेकरेस्ट
FI	Selkänöja	TH	พนักพิง
DA	Ryglæn	SQ	Mbështetësja e shpinës
ET	Seljatugi	BS	Naslon
LV	Atzveltnē	ME	Naslon
LT	Nugaros atlošas	MK	Наслон за грб
RU	Спинка	HY	Թիկակալ
UK	Спинка	VI	Phàn tựa lưng



= 43

EN	Legrest	TR	Bacak desteği
DE	Beinstütze	EL	Στήριγμα ποδιών
ES	Reposapiés	RO	Suport picior
FR	Repose-pieds	IS	Fótahvíla
PT	Apoio de pernas	MT	Serħ is-saqajn
IT	Poggiagambe	AR	ميمسد الساق
NL	Beensteun	FA	جاپایوی
PL	Podnózek	YUE	腿托
CS	Opěrka nohou	CMN	腿托
SK	Opierka nôh	JA	足のせ
SL	Naslon za noge	KO	다리받이
HR	Naslon za noge	BG	Подложка за крака
HU	Lábtartó	SR	Naslon za noge
SE	Benstöd	MS	Tempat letak kaki
NO	Benstøtte	HI	लेगरेस्ट
FI	Jalkatuki	TH	ที่วางขา
DA	Benstøtte	SQ	Mbështetësja e këmbëve
ET	Jalatugi	BS	Naslon za noge
LV	Kāju balsts	ME	Naslon za noge
LT	Kojų atrama	MK	Наслон за нозе
RU	Подставка для ног	HY	Ուղեքրի հեւման կտտ
UK	Опора для ніг	VI	Phàn tựa chân

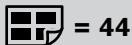

= 44

EN	Sun canopy	TR	Güneş başlığı
DE	Sonnenverdeck	EL	Κουκούλα για τον ήλιο
ES	Capota para el sol	RO	Copertină
FR	Pare-soleil	IS	Sólartjald
PT	Capota solar	MT	Kopertura mix-xemx
IT	Parasole	AR	مظلة الشمس
NL	Zonnekap	FA	سایبان
PL	Oslona	YUE	遮陽蓬
CS	przeciwsłoneczna	CMN	遮阳蓬
SK	Strieška proti slnku	JA	日よけカバ-
SL	Senčnik za zaščito pred soncem	KO	선 캐노피
HR	Tenda za sunce	BG	Тента
HU	Kupola	SR	Tenda za sunce
SE	Solsufflett	MS	Kanopi matahari
NO	Solskjerm	HI	धूप छतरी
FI	Aurinkokatot	TH	หลังคาบังแดด
DA	Solkaleche	SQ	Strea për diellin
ET	Päikesevari	BS	Tenda za sunce
LV	Saules aizsegs	ME	Tenda za sunce
LT	Stogelis nuo saulės	MK	Стреа за сонце
RU	Солнцезащитный козырек	HY	Սրիւսապաշտպաւն ծածկ
UK	Тент від сонця	VI	Mái che nắng

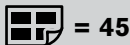

= 45

EN	Handle bar	TR	Tutma sapı
DE	Schiebegriff	EL	Ράβρος λαβής
ES	Manillar	RO	Mâner
FR	Poignée de poussée	IS	Handfang
PT	Guiador	MT	Handle bar
IT	Manubrio	AR	عارضضة المقبض
NL	Duwstang	FA	میله دسته
PL	Uchwyt	YUE	把手
CS	Madlo	CMN	把手
SK	Rukoväť	JA	ハンドルバー
SL	Ročaj	KO	핸들 바
HR	Ručice	BG	Кормило
HU	Tolókar	SR	Ručke
SE	Handtag	MS	Bar pemegang
NO	Håndtak	HI	हैंडल बार
FI	Työntökahva	TH	ด้ามจับ
DA	Styr	SQ	Shufra e dorezës
ET	Sang	BS	Ručice
LV	Rokturis	ME	Ručke
LT	Rankena	MK	Рачка
RU	Рукоятка	HY	Վարապարման բռնակ
UK	Рукоятка	VI	Tay càm



 = 46

EN Swivel locks	TR Tekerlek kilidi
DE Schwenkradsperre	EL Περιστρεφόμενες κλειδαριές
ES Bloqueos de dirección	RO Încuietori pivotante
FR Verrous pivotants	IS Snúningslásar
PT Bloqueios de rotação	MT Lokks li jduru
IT Blocchi girevoli	AR أقفال دوران العجلات
NL Zwenkvergrendeling	FA قفل های نوسان
PL Blokada obrotu	YUE 旋轉鎖
CS Aretační zámky	CMN 旋转锁
SK Aretačné zámky	JA 回転ロック
SL Blokada vrtenja	KO 회전 잠금장치
HR Zaključavanje okretanja	BG Завъртащи се ключалки
HU Beállás-zár	SR Zakretni mehanizmi
SE Vridlås	MS Kunci ayun
NO Svingelåser	HI कुंडा ताल
FI Kääntöluukko	TH ตัวลิ้อคแบบหมุน
DA Drejelås	SQ Kucja e rrotave
ET Pöördlukustus	BS Zakretni mehanizmi
LV Rotācijas bloķētāji	ME Zakretni mehanizmi
LT Šarnyriniai fiksatoriai	MK Заклучување на тркалата
RU Блокировки вращения	HY Դառնային կողպիչներ
UK Замок шарніра	VI Khóa xoay



 = 47

EN Removing the wheels	TR Tekerlekleri çıkarma
DE Entfernen der Räder	EL Αφαίρεση των τροχών
ES Quitar las ruedas	RO Îndepărtarea roților
FR Retrait des roues	IS Fjarlægja hjól
PT Remover as rodas	MT Tneħhija tar-roti
IT Rimozione delle ruote	AR فك العجلات
NL De wielen verwijderen	FA باز کردن چرخها
PL Zdejmowanie kółek	YUE 拆卸車輪
CS Odstranění koleček	CMN 拆卸车轮
SK Odstránenie koliesok	JA 車輪の取り外し
SL Odstranjevanje koles	KO 휠 제거
HR Uklanjanje kotača	BG Демонтиране на колелата
HU Kerekeltávolítás	SR Uklanjanje točkova
SE Ta bort hjulen	MS Menanggalkan roda
NO Fjerne hjulene	HI पहियों को हटाना
FI Pyörien poisto	TH การถอดล้อ
DA Fjernelse af hjulene	SQ Heqja e rrotave
ET Rataste eemaldamine	BS Uklanjanje točkova
LV Riteņu atvienošana	ME Uklanjanje točkova
LT Ratų nuėmimas	MK Отстранување на тркалата
RU Снятие колес	HY Անիվները հանելը
UK Зняття коліс	VI Tháo bánh xe



 = 48

EN	Removing the fabric	TR	Kilifi çıkarma
DE	Entfernen des Bezuges	EL	Αφαίρεση του υφάσματος
ES	Quitar la tela	RO	Îndepărtarea țesăturii
FR	Retrait du tissu	IS	Fjarlægging efni
PT	Remover o tecido	MT	Tnehhija tad-drapp
IT	Rimozione del tessuto	AR	فك القماش
NL	De stof verwijderen	FA	برداشتن پارچه
PL	Zdejmowanie pokrycia	YUE	拆除罩布
CS	Odstranění látky	CMN	拆除罩布
SK	Odstránenie látky	JA	カバーの取り外し
SL	Odstranjevanje blaga	KO	페브릭 제거
HR	Uklanjanje tkanine	BG	Демонтиране на плата
HU	Huzat eltávolítása	SR	Uklanjanje tkanine
SE	Ta bort tyget	MS	Menanggalkan fabrik
NO	Fjerne stoffet	HI	कपड़ा हटाना
FI	Kankaan poisto	TH	การถอดผ้า
DA	Fjernelse af stoffet	SQ	Heqja e copës
ET	Kanga eemaldamine	BS	Uklanjanje tkanine
LV	Pārklājuma atvienošana	ME	Uklanjanje tkanine
LT	Audinio nuėmimas	MK	Отстранување на навлаката
RU	Снятие ткани	HY	Գործվածքը հանելը
UK	Зняття матерії	VI	Tháo phần vải bọc



 = 62

EN	Rain cover	TR	Yağmurluk
DE	Regenverdeck	EL	Καλύπτρα βροχής
ES	Funda para la lluvia	RO	Prelată de ploaie
FR	Housse de pluie	IS	Regn yfirbreiðsla
PT	Capa de chuva	MT	Għata mix-xita
IT	Parapioggia	AR	غطاء المطر
NL	Regenhoes	FA	روکش باران
PL	Oslona od deszczu	YUE	防雨罩
CS	Pláštěnka	CMN	防雨罩
SK	Kryt proti dažďu	JA	雨よけ
SL	Dežna prevleka	KO	레인커버
HR	Pokrivač za kišu	BG	Дъждобран
HU	Esővédő	SR	Pokrivač za kišu
SE	Regnskydd	MS	Pelindung hujan
NO	Kalesje	HI	रेन कवर
FI	Sadesuoja	TH	ผ้าคลุมกันฝน
DA	Regnslag	SQ	Mbulesë për shiun
ET	Vihmakate	BS	Pokrivač za kišu
LV	Pretlietus pārvalks	ME	Pokrivač za kišu
LT	Uždangalas nuo lietaus	MK	Прекиривка за дожд
RU	Дождевик	HY	Մուրակամպարային ծածկ
UK	Дощовик	VI	Tấm che mưa

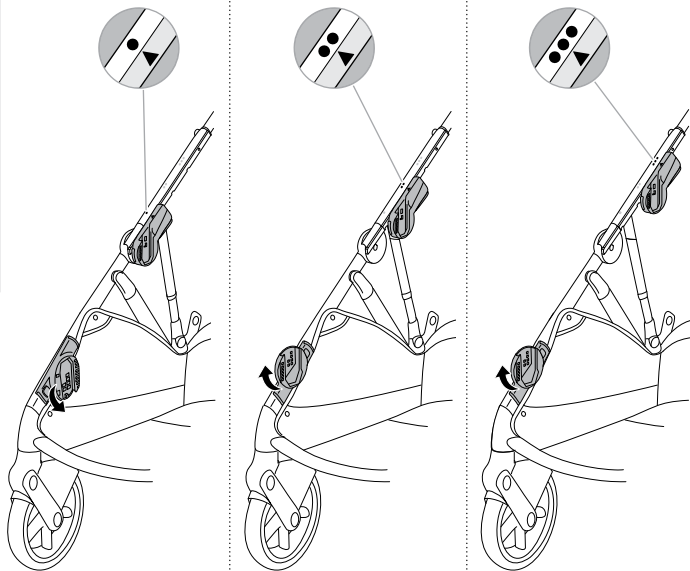



max. 9 kg

max. 10 kg

max. 13 kg

max. 15 kg

max. 22 kg



max. 9 kg

max. 10 kg

max. 13 kg

max. 15 kg

max. 22 kg

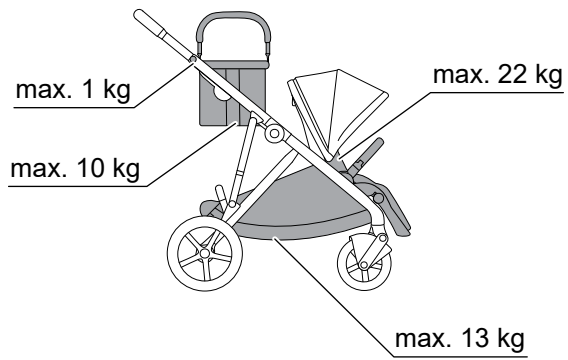



180°

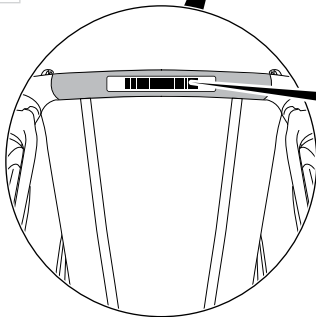

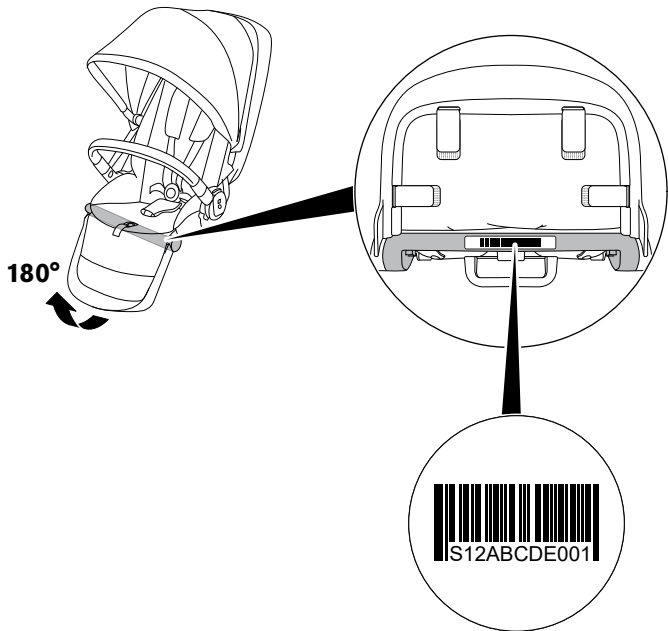

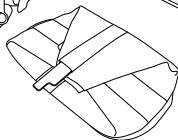
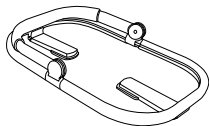
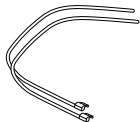
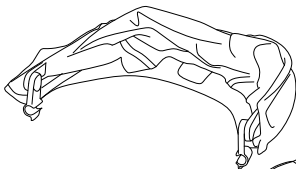
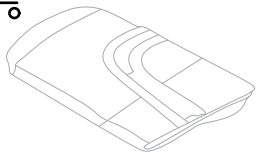
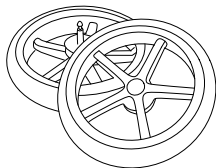
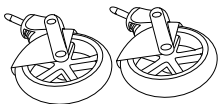
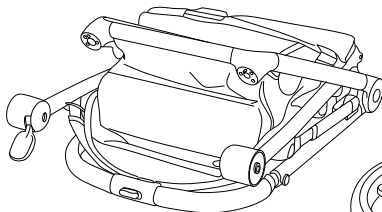

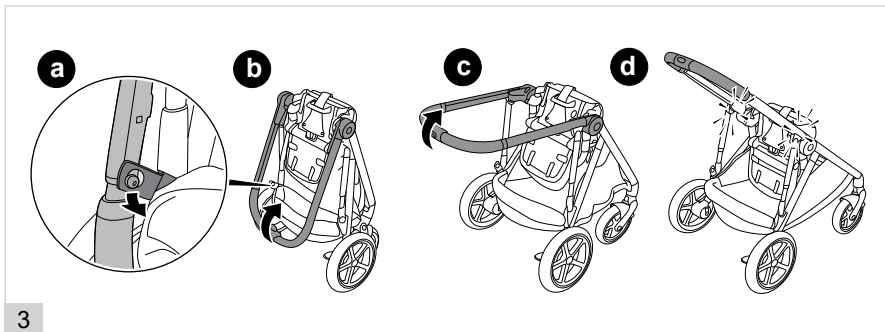
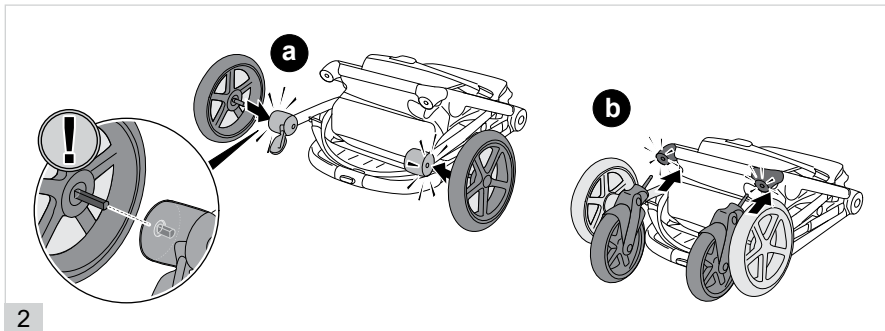

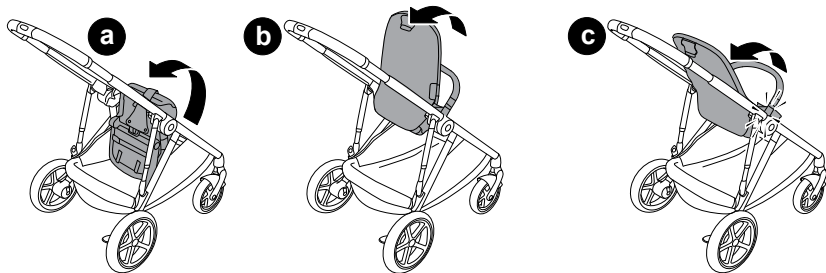

4

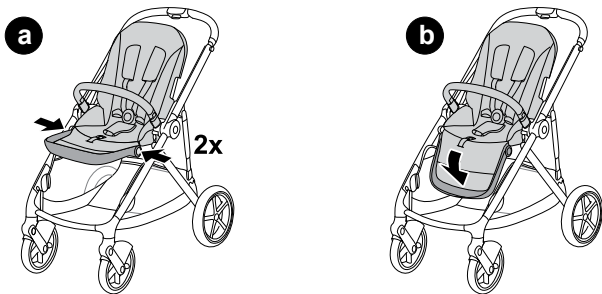

5

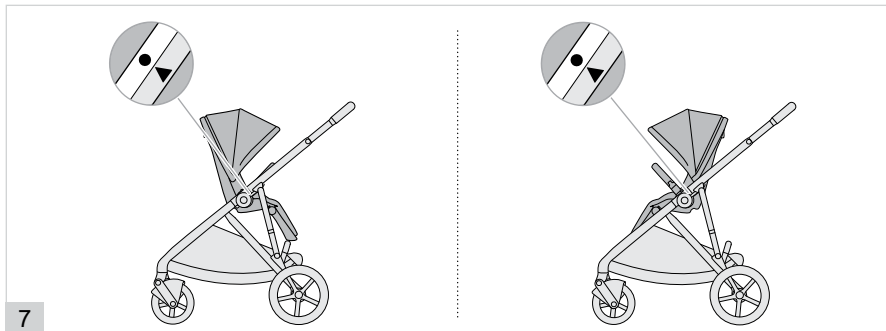
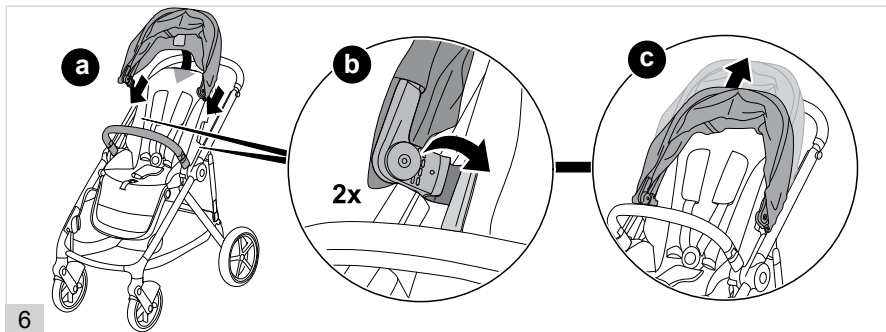

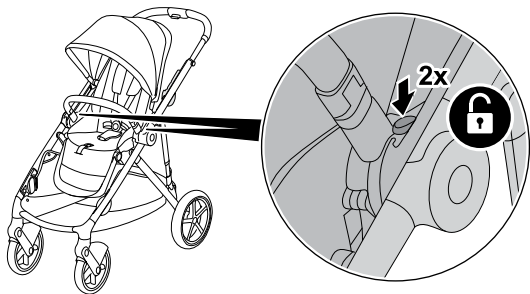

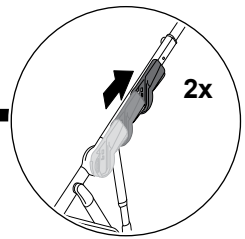
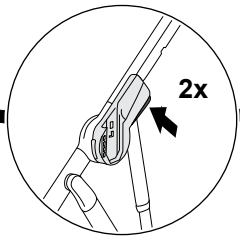
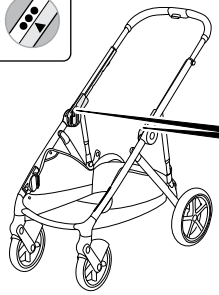

2

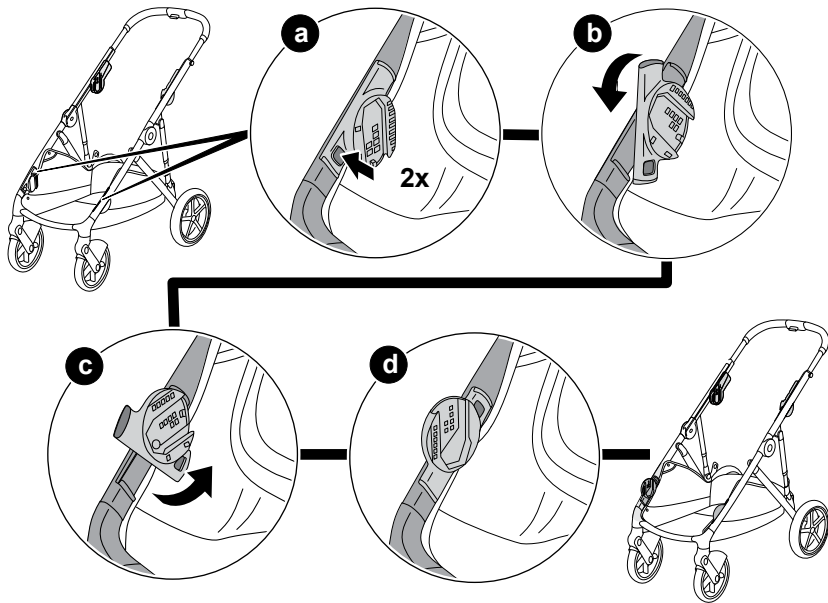

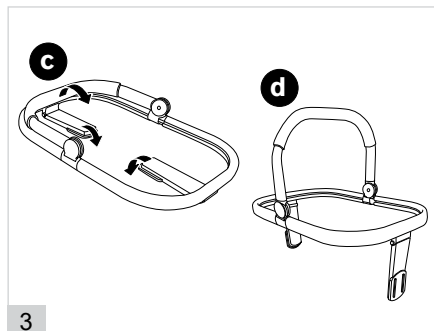
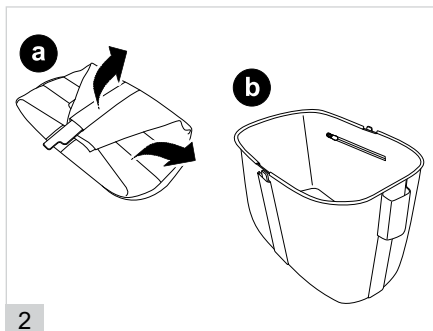
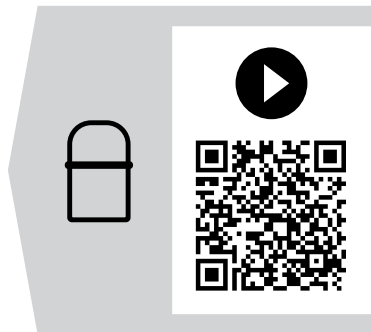
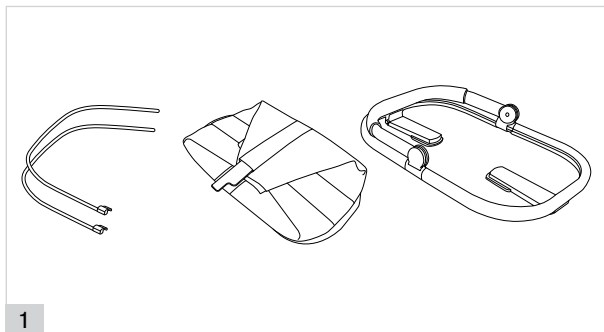

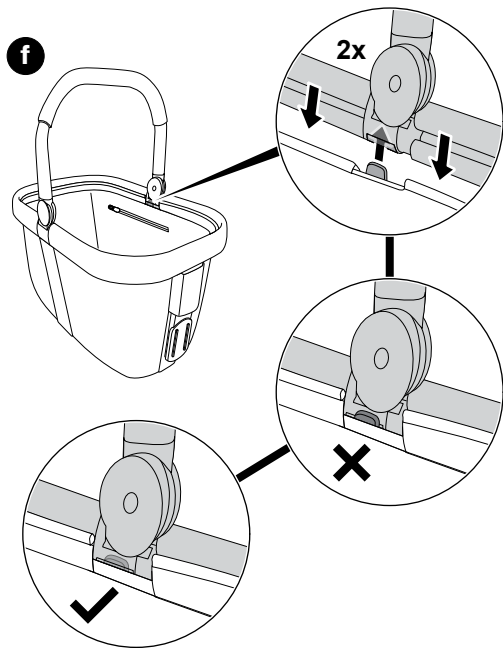
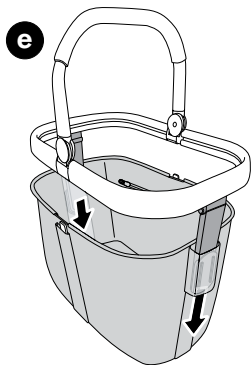

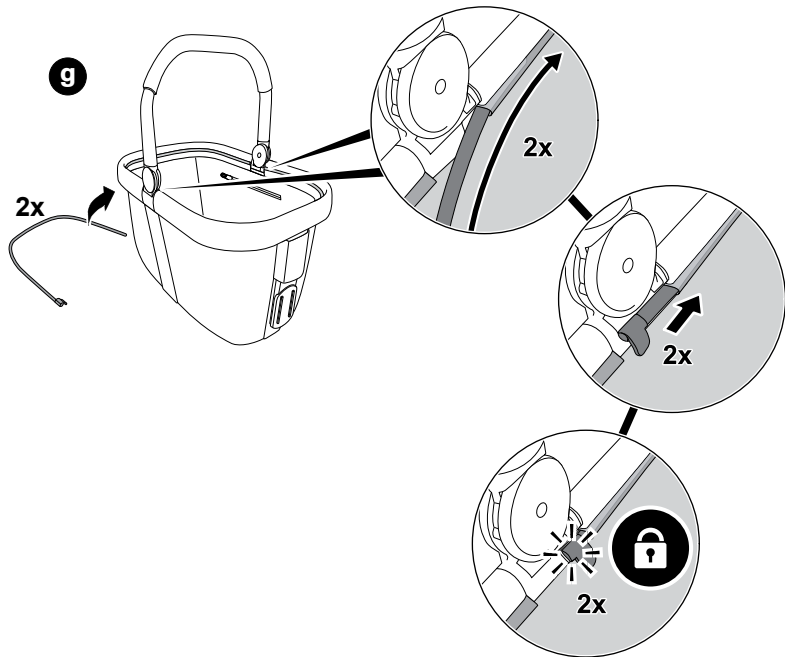

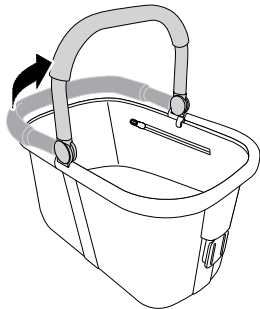

6

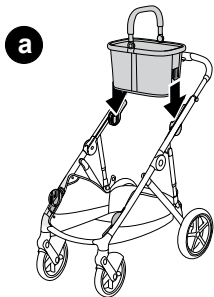

a

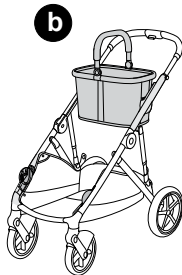

b



c

7

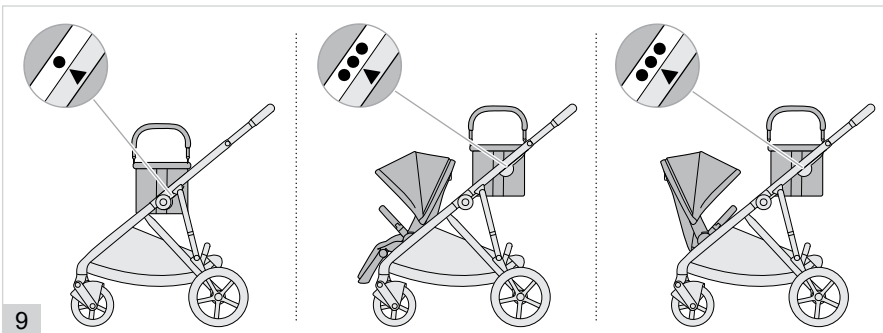

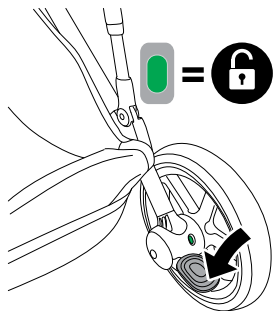
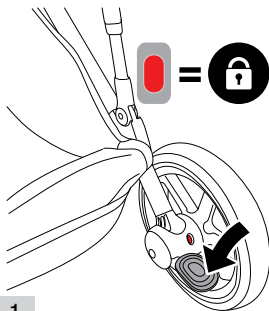

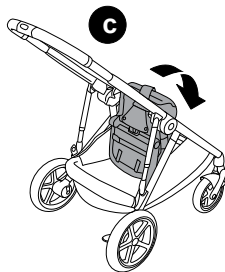
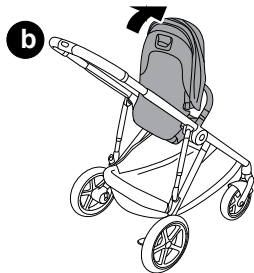
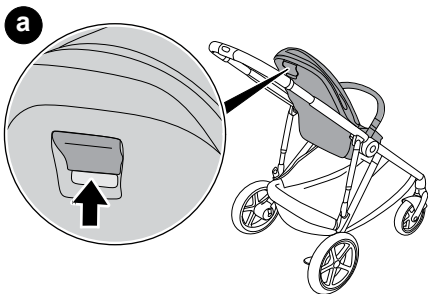

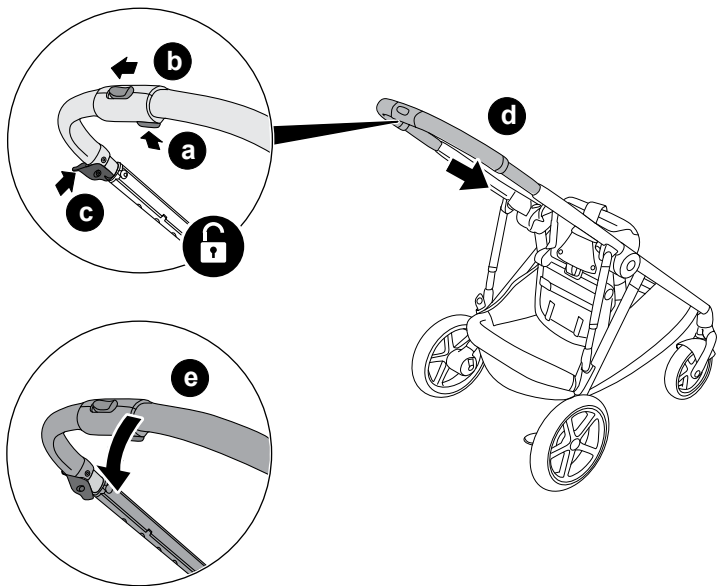

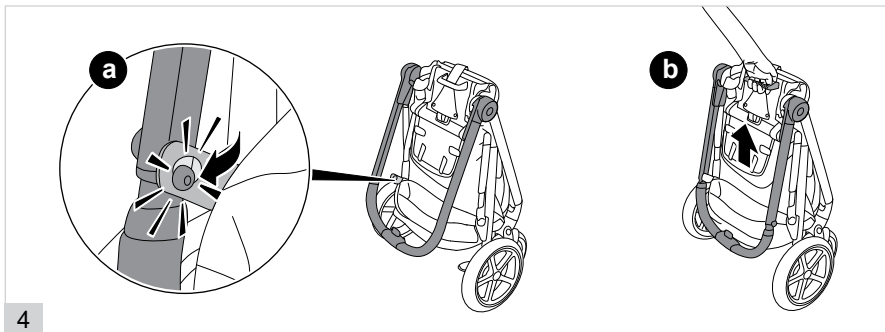
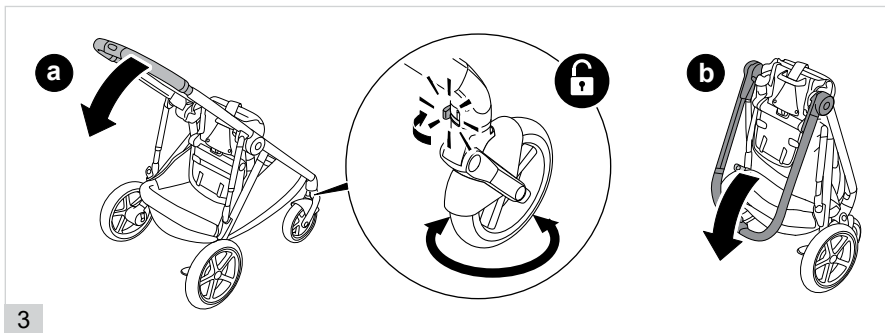

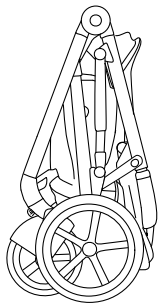

5



36

a

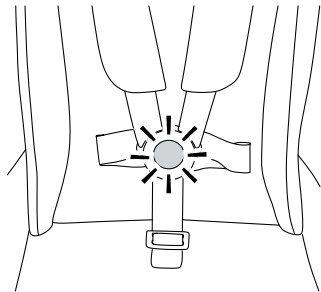

1

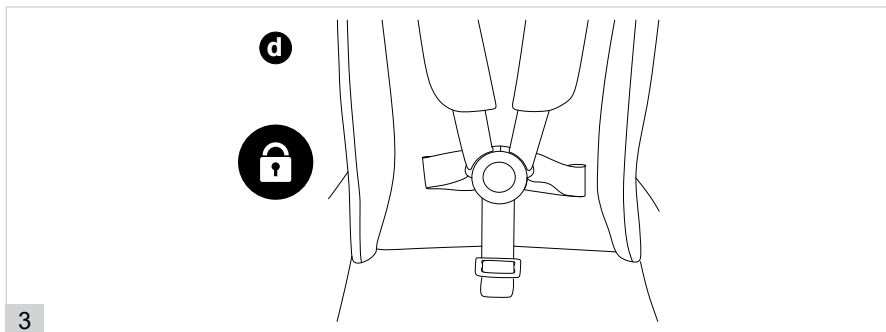
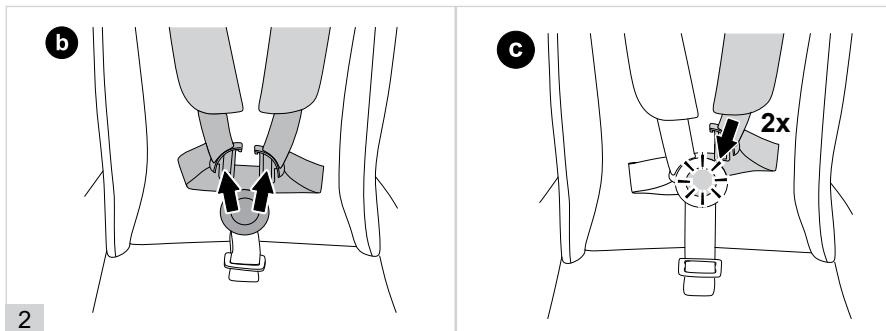



a

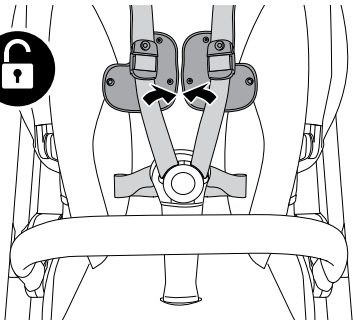

b

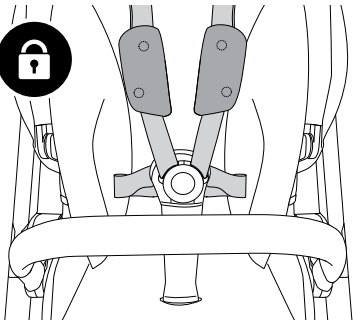

4

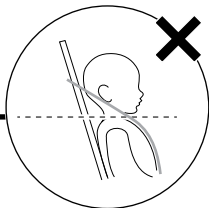
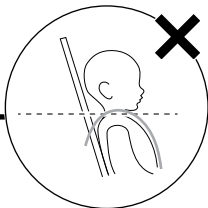
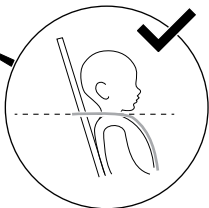
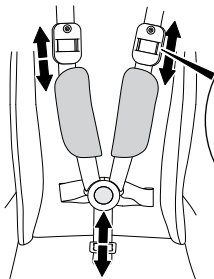

5

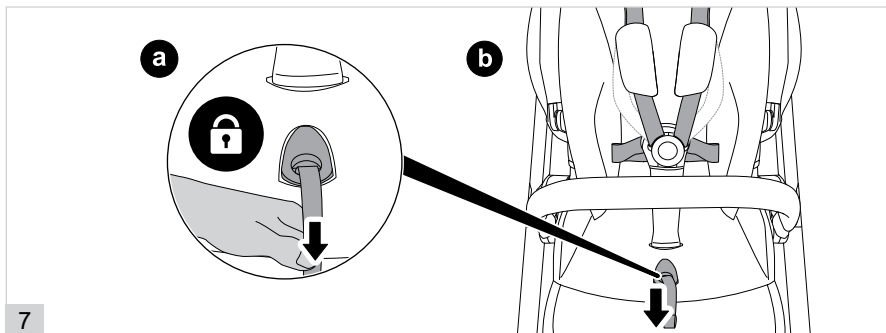
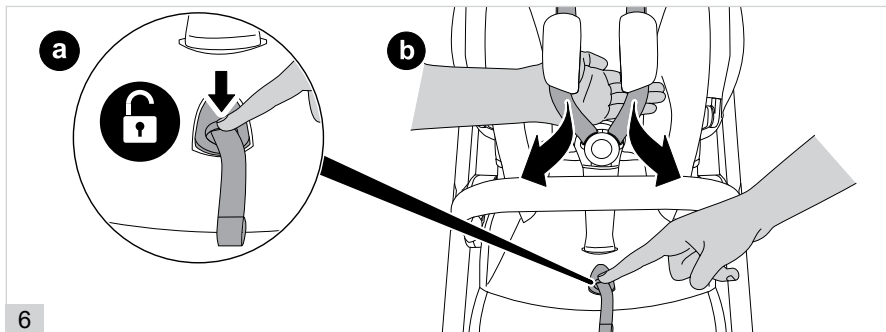

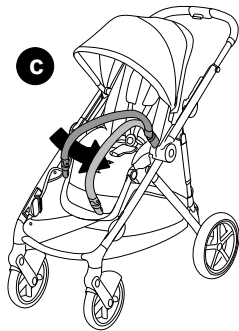
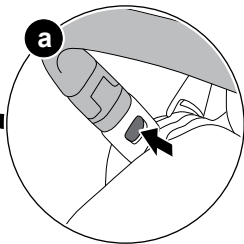
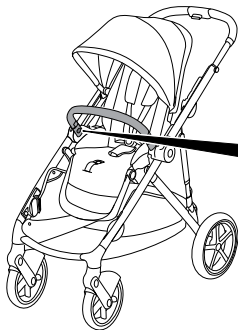

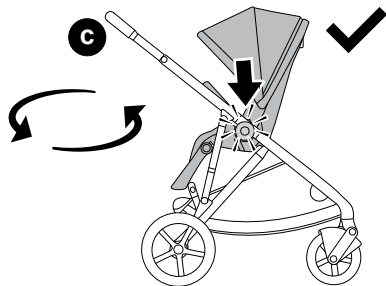
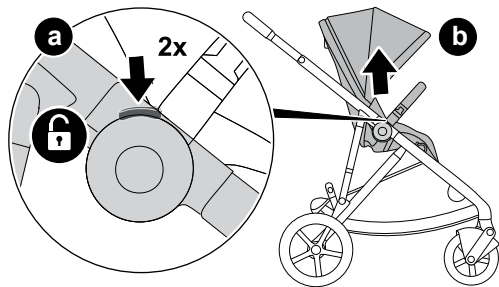

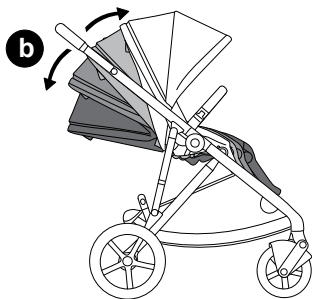
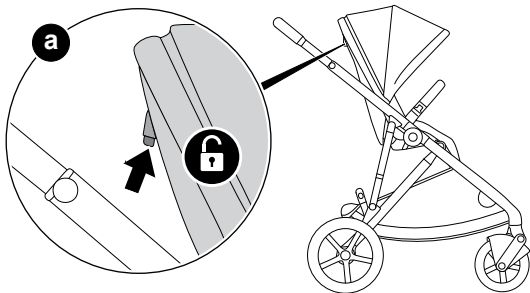

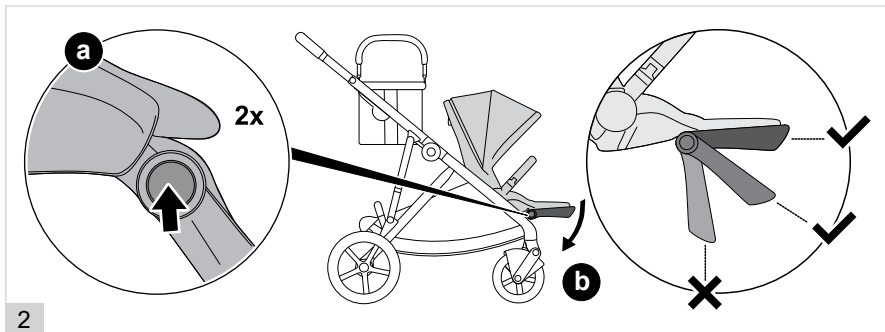
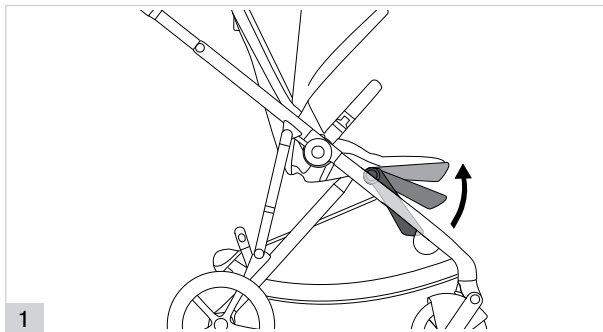



1

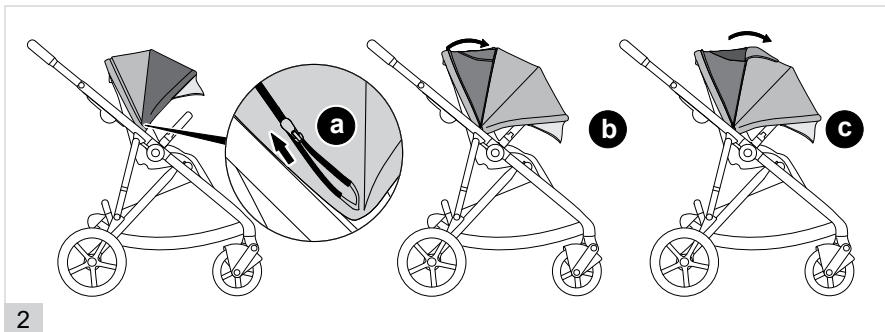
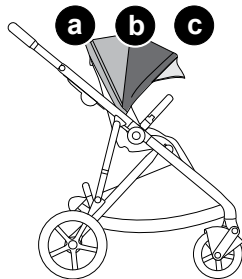
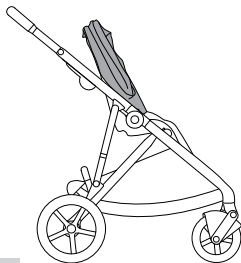

44

2

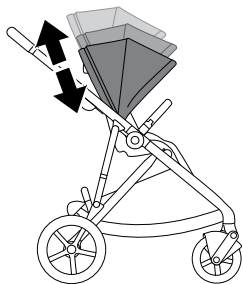

3

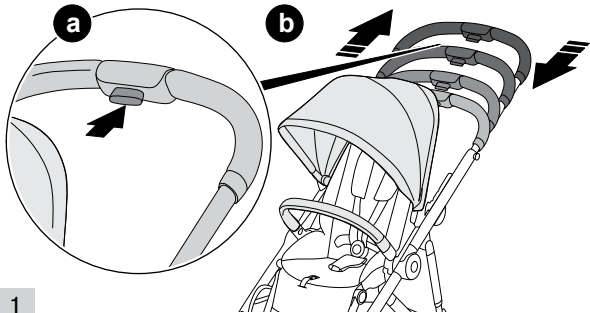

1





click

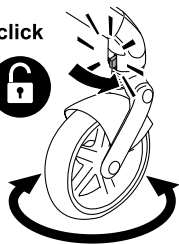

click

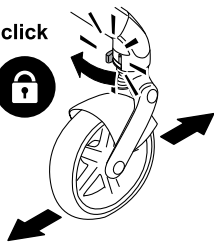

1

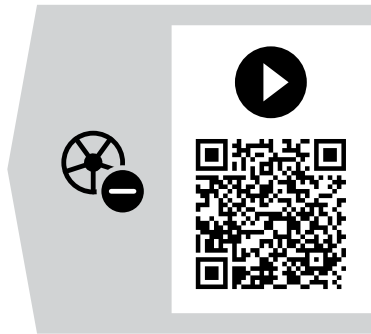
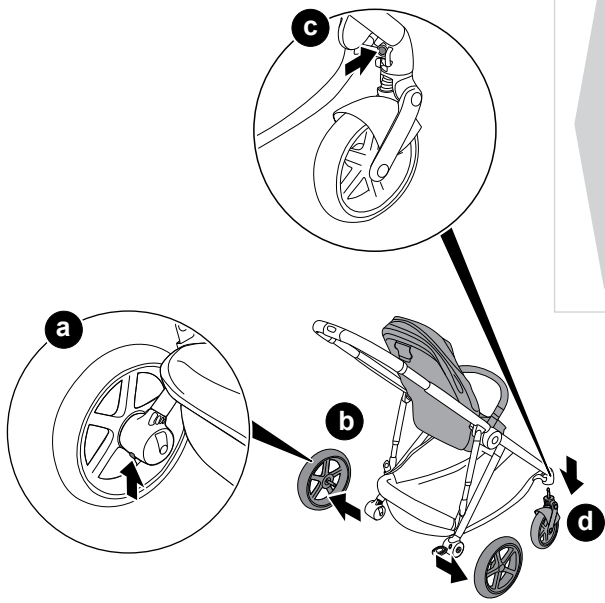

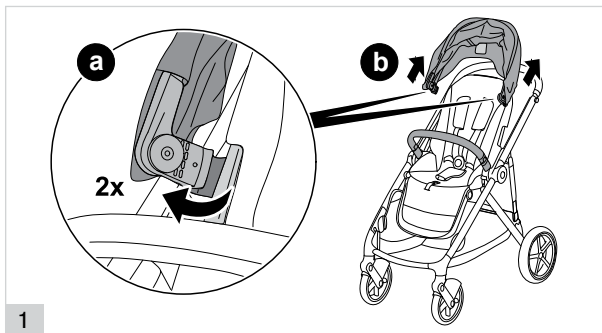

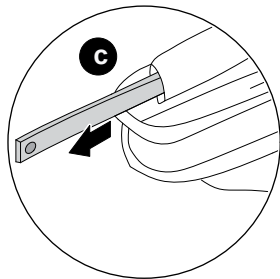
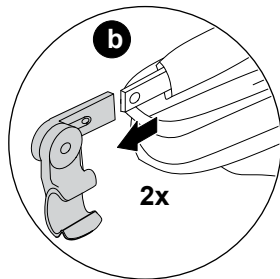
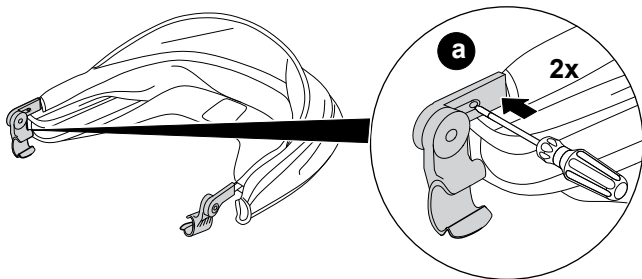

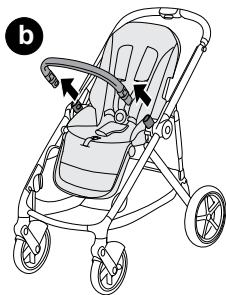
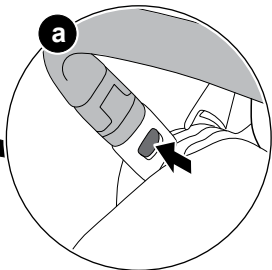
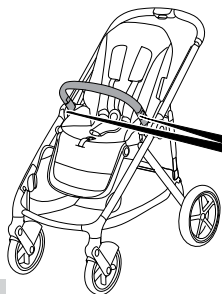

3

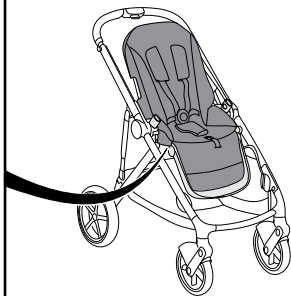
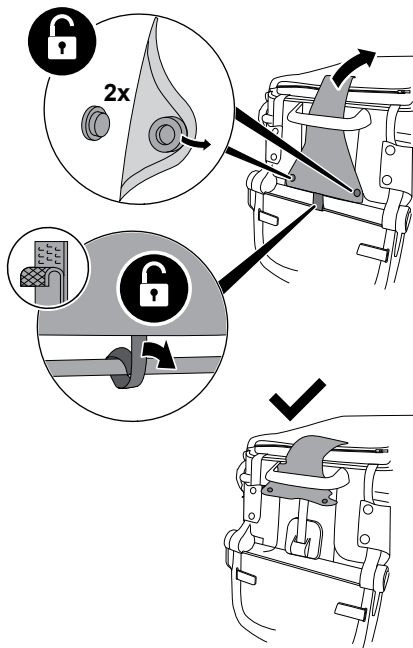

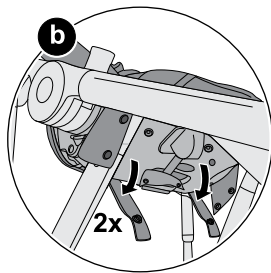
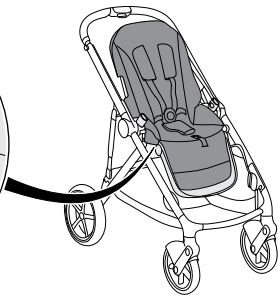
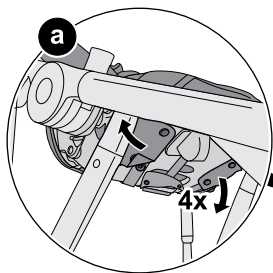

5

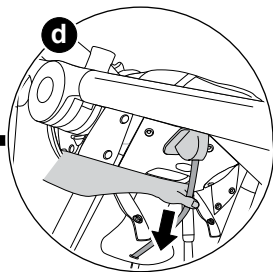
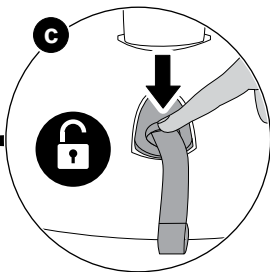

52

6

e

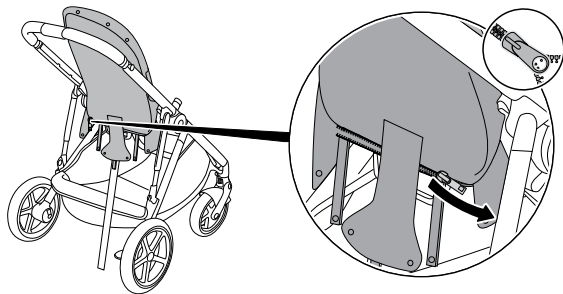

7

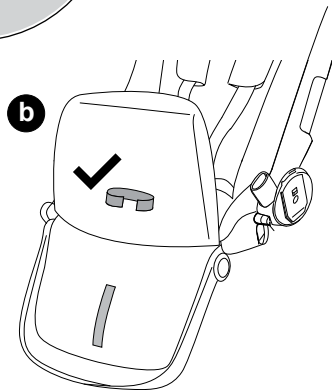
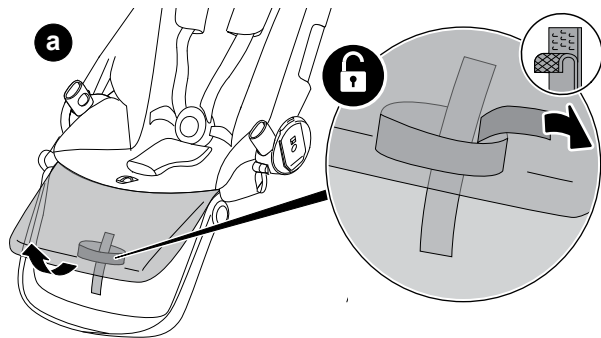

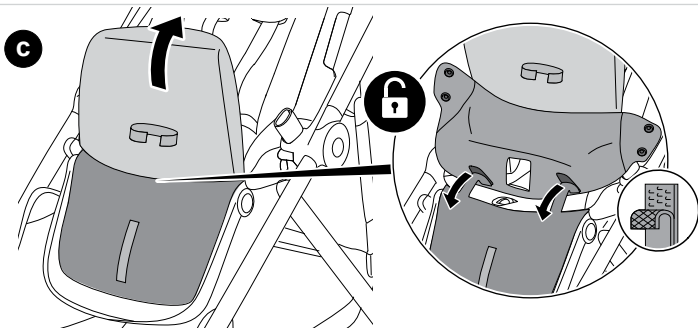

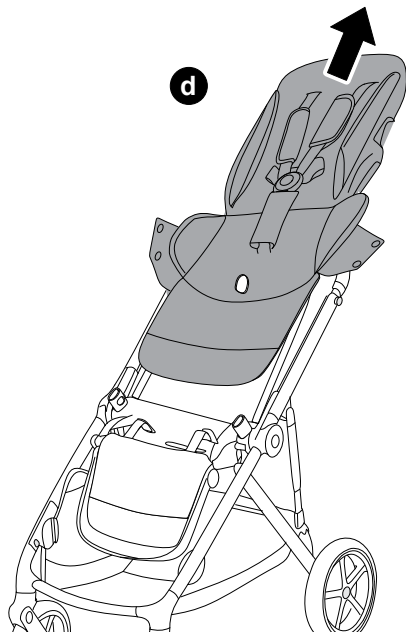



4x



11

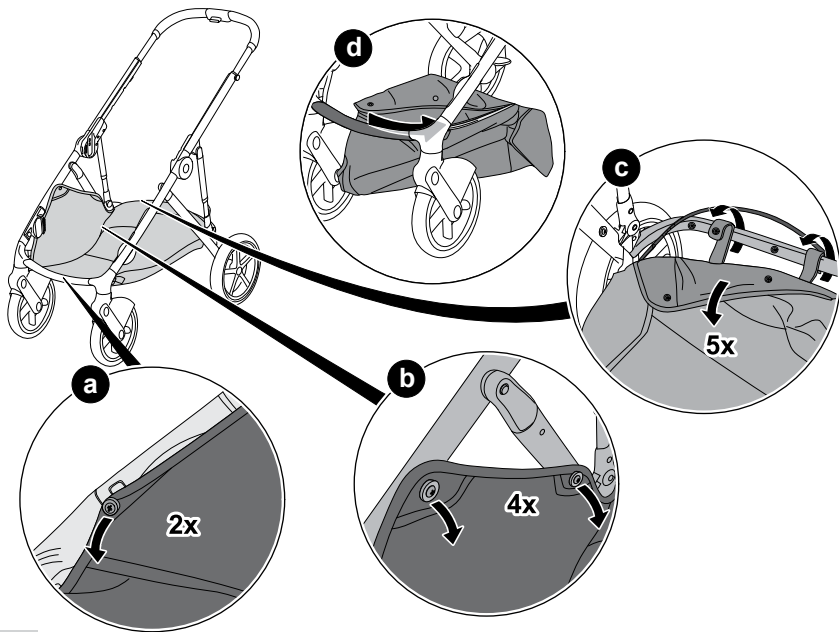

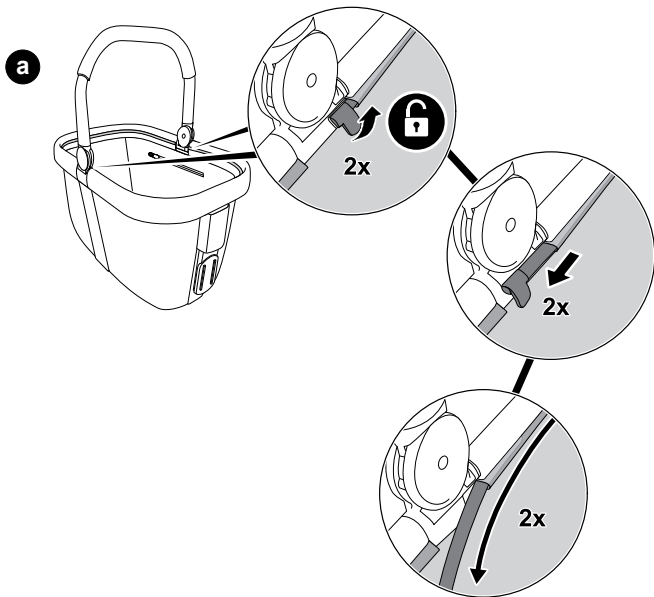



b

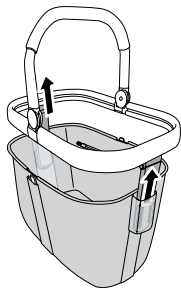

14

c

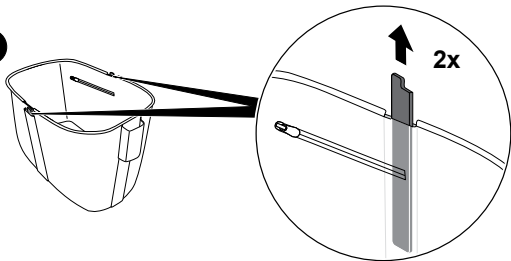

60

15

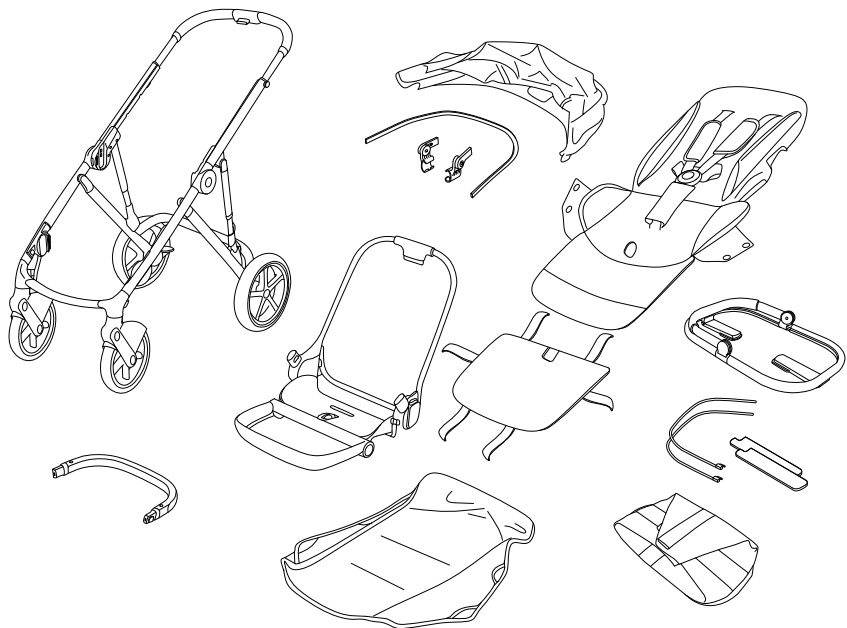

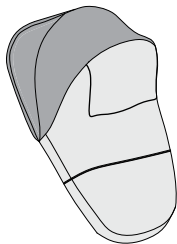

1

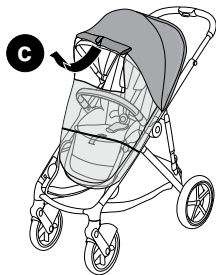
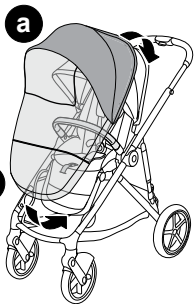



a



b

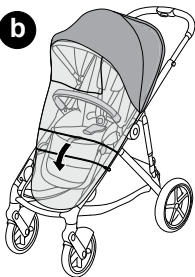

c

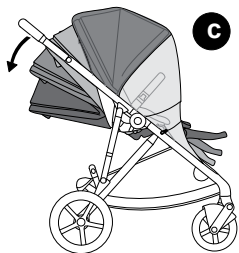

3

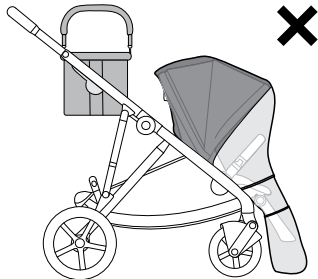
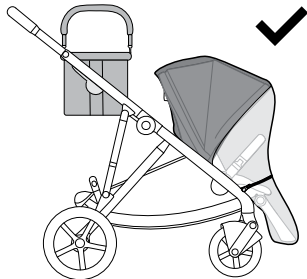

4



CYBEX GmbH
Riedingerstr. 18 | 95448 Bayreuth | Germany
+49 (0) 921-78 511-0 | info@cybex-online.com
www.cybex-online.com



FR
Cet appareil
et ses accessoires
se recyclent

À DÉPOSER
EN MAGASIN

À DÉPOSER
EN DÉCHÈTERIE

OU



Points de collecte sur www.quefairedemesdechets.fr